



# ***Smoke Sensor***

***Model CFS10***



## ***Owner's Manual***

### ***Combination Sensor***

- **Photoelectric Smoke Sensing**
- **Rate of Rise Temperature Sensing**
- **Fixed Temperature Sensing**
- **Proprietary Wireless Connectivity**
- **Compatible with the Comm Link and OmniShield App**

Assembled in the USA



SIGNALING  
c **UL** US  
LISTED

# Table of Contents

General Information About Your New Dual Detector Smoke Sensor .....	page 3
Contents of Your Kit .....	page 4
Recommended Locations for Your Smoke Sensor .....	page 5
Areas Not Appropriate for Smoke Sensors .....	page 6
National Fire Protection Association Standards .....	page 7
Complete Home Fire Protection .....	page 8
Acceptable Radio Network Smoke Sensor Spacing .....	page 8
Sensor Features and Functions .....	page 9 - 10
Deactivating Your CFS10 Smoke Sensor .....	page 11
Creating Your Wireless Network .....	page 12
Adding a Sensor to Your Wireless Network .....	page 13
Removing a Sensor from Your Wireless Network .....	page 14
Choosing the Mounting Location in a Room .....	page 15
How to Mount the Battery Powered Smoke Sensor .....	page 16
How to Wire and Mount the AC Powered Sensor .....	page 17
Cleaning the Smoke Sensor .....	page 18
Smoke Sensor Specifications .....	page 19
Important Fire/Emergency Safety Information .....	page 20
Warning! Limitations on Smoke Sensors .....	page 21
Limited Warranty .....	page 22
Replacement Guarantees .....	page 23

*Applied Fire Technologies recommends a combination of early-detecting Smoke Sensors, CO Sensors and reliable Heat Sensors installed in their appropriate locations throughout the home.*

*Heat, CO and Smoke Sensors are not a substitute for an adequate homeowner's fire insurance policy.*

## About Your New Dual Detector Smoke Sensor

Thank you for purchasing the CFS10 Smoke Sensor. Smoke sensors play an important role in protecting your family and home from the dangers of fire. Please carefully read and follow the information in this booklet to ensure that your sensors operate properly and are located in the areas best suited for activation.

## What Makes the CFS10 Smoke Sensor Different?

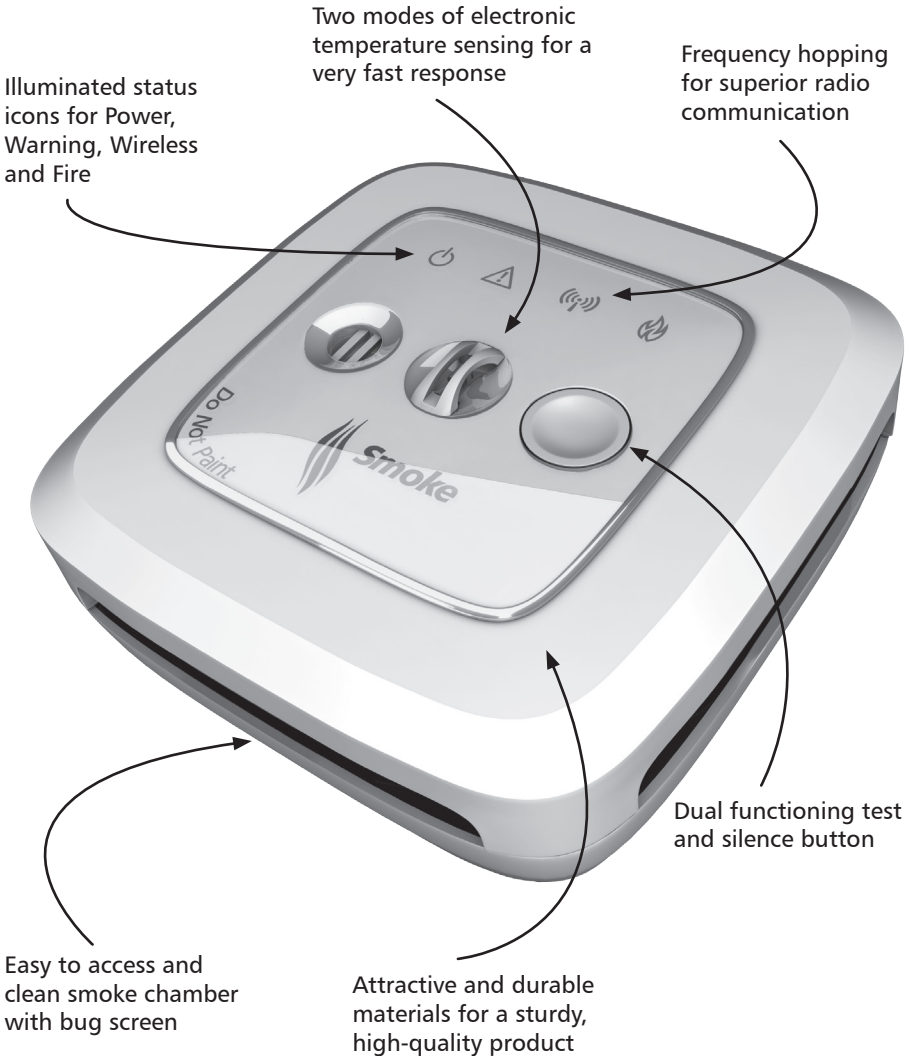

# Contents of Your Kit

Please make sure the following is included with your sensor:

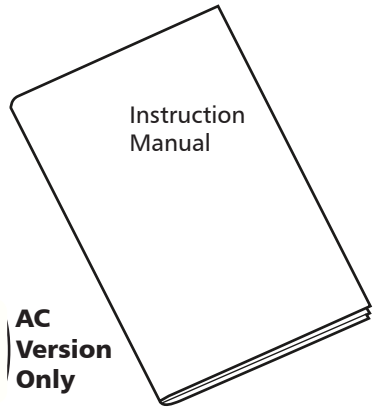
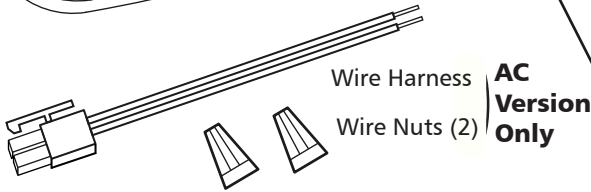
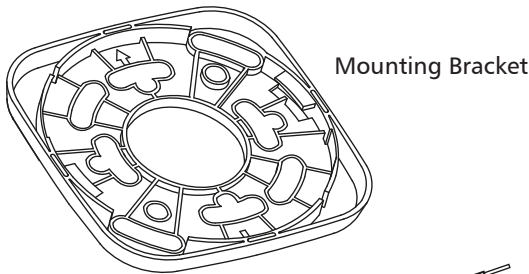

## Key Features

- The latest photoelectric smoke sensing technology.
- Electronic temperature sensing with Rate of Rise and Fixed Temperature triggers.
- Radio communication that connects all products into a unique home network.
- Powered by a sealed, long-life Lithium Manganese battery.
- Easy maintenance with a quick-twist removable smoke chamber design.
- Four illuminated icons to demonstrate smoke sensor status.
- Multi-function button to allow for testing and silencing of unwanted triggering.
- Uniquely loud horn to notify occupants of fire danger.
- Top quality construction to ensure beautiful appearance and durability.
- Compatible with the Comm Link and OmniShield App.

## Recommended Locations for Your Smoke Sensor

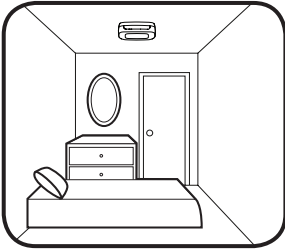

**Bedrooms.** A major threat from fire occurs at night when people are sleeping. Smoke alarms are required protection in all sleeping rooms.

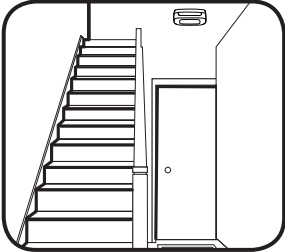

**Hallways.** A principal threat to people sleeping in bedrooms comes from fires elsewhere in the home. A smoke alarm is required to be located outside of each sleeping area, and on every level of the home.

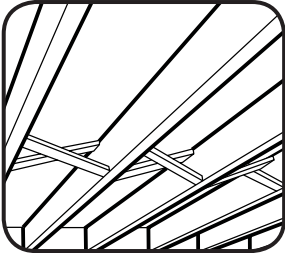

**Basements.** A smoke alarm is required on every level of the house, including the basement near the stairway leading to the floor above.

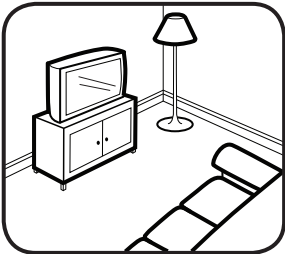

**Living Rooms.** To enhance safety, a smoke sensor should be located in the living room of a home.

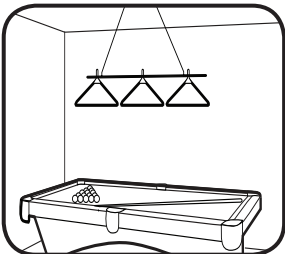

**Recreation and Dining Rooms.** For additional protection, a smoke sensor can be located in the other living spaces of the home.

## Areas Not Appropriate for Smoke Sensors

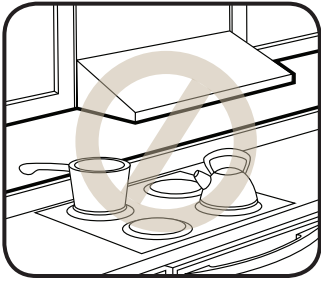

**Kitchens.** Do not install near kitchen appliances. Steam and by-products of cooking might cause nuisance alarms.

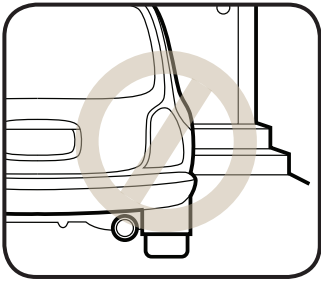

**Garages.** Do not install in garages. Exhaust gases from vehicles can trigger the smoke sensors.

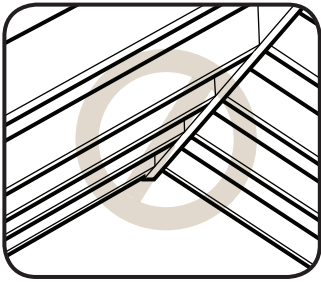

**Attics.** Do not install in attics. A smoke sensor can be affected by dust, small insects or high temperatures. Do not install the unit in areas where the normal ambient temperature can exceed 100°F (38°C).

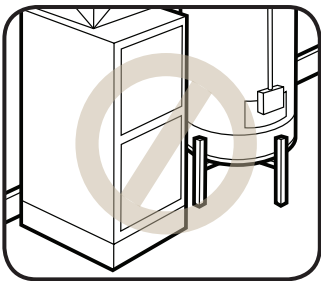

**Utility and Furnace Rooms.** Do not install close to equipment that can create steam and gas. Steam and gas can trigger the smoke sensor.

# National Fire Protection Association Standards

This equipment should be installed in accordance with the National Fire Protection Association's Standard 72 (National Fire Protection Association, Batterymarch Park, Quincy, MA 02269).

For your information, the National Fire Protection Association's Standard 72, 2013 Edition, Section 29.5.1 covering required protection in One- and Two-Family Dwelling Units, reads as follows:

**29.5.1.1 Required Detection.** Where required by other governing laws, codes, or standards for a specific type of occupancy, approved single- and multiple-station smoke alarms shall be installed as follows:

- (1) In all sleeping rooms and guest rooms.
- (2) Outside each separate dwelling unit sleeping area, within 21 ft (6.4 m) of any door to a sleeping room, with the distance measured along a path of travel.
- (3) On every level of the dwelling unit, including basements.
- (4) On every level of a residential board and care occupancy (small facility), including basements and excluding crawl spaces and unfinished attics.
- (5) In the living area(s) of a guest suite.
- (6) In the living areas(s) of a residential board and care occupancy (small facility).







## **A.29.5.1 (NFPA 72 2013 Edition) "Are More Smoke Detectors Desirable?"**

The required number of smoke detectors might not provide reliable early warning protection for those areas separated by a door from the areas protected by the required smoke detectors. For this reason, it is recommended that the householder consider the use of additional smoke detectors for those areas for increased protection. The additional areas include the basement, bedrooms, dining room, furnace room, utility room, and hallways not protected by the required smoke detectors. The installation of smoke detectors in kitchens, attics (finished or unfinished), or garages is not normally recommended as these locations occasionally experience conditions that can result in improper operation."

**Note:** *Applicable building codes or other local laws may require the installation of additional fire alarms in addition to the minimum recommended by the NFPA.*

# Complete Home Protection

Applied Fire Technologies recommends complete home fire/safety protection. This can be best achieved by installing a combination of Smoke, CO, Heat Sensors, BedShakers, Water Sensors and a Comm Link in the appropriate locations throughout the home.

-  Minimum Required Smoke Sensors
-  Minimum Required CO Sensors
-  Recommended Heat Sensors
- Required Interconnections
-  Recommended BedShakers
-  Recommended Comm Link
-  Recommended Water Sensors

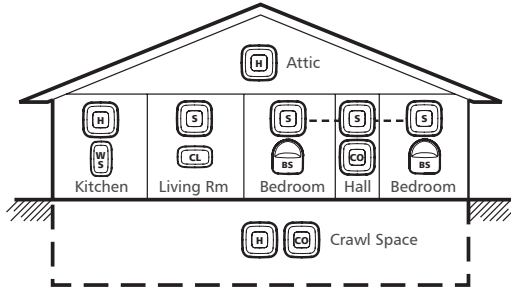

**Single Story Homes**

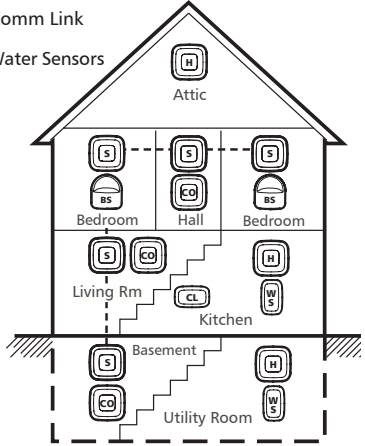

**Two Story Homes**

# Acceptable Radio Network Smoke Sensor Spacing

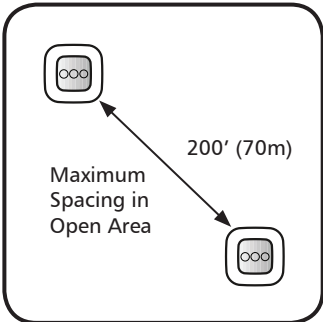

The proprietary network communicates using radio frequencies between 905.2MHz and 913.2MHz.

The range of the radio has been tested to 200 feet (70m) in open area distance testing.

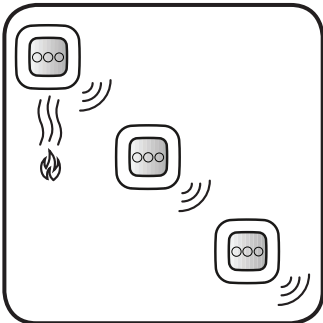

Each unit will also act as a repeating station, so any signal received by a sensor will be rebroadcast.

**After final installation, test all sensors for proper wireless inter-connection. Simply press and release the test button of a sensor while having a helper observe the remote sensors.**



## Sensor Features and Functions

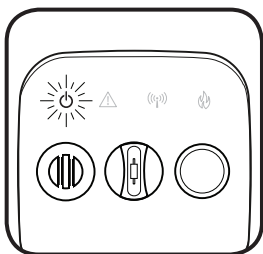

### Power Indicator Light (Green)

On the CFS10 (battery-only powered), the POWER icon will briefly flash every 30 seconds once the smoke sensor has been activated.

On the CFS10-AC (AC with battery backup), the POWER icon will glow continuously while AC powered.

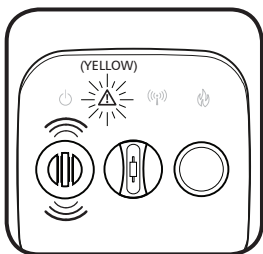

### Warning Light (Yellow)

WARNING will flash yellow every 30 seconds, accompanied by the horn chirp to indicate the smoke chamber needs to be removed and cleaned.

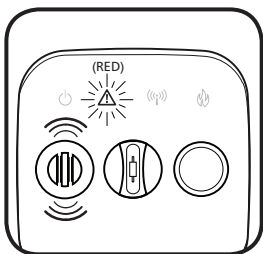

### Warning Light (Red)

WARNING will flash red every 30 seconds accompanied by the horn chirp, for a minimum of 7 days, to indicate **Low Battery**. Replace the unit.

WARNING will **double flash** red every 30 seconds accompanied by the horn chirp, to indicate that the smoke sensor has reached its **End-of-Life**. Replace the unit.

WARNING can also be activated by a remote signal from a **CO Alarm**. In this case, WARNING will be solid red accompanied by 4 beeps of the horn.

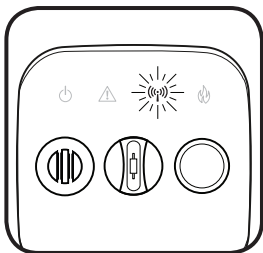

### Wireless Networking Light (Blue)

WIRELESS will flash once per second to indicate the wireless network is open to accept additional sensors into the network.

WIRELESS will cease to flash one minute after the last unit has been added to the network or immediately after the button has been pressed.

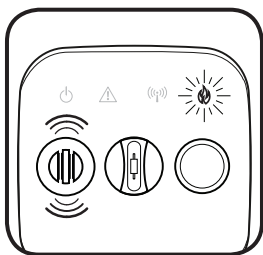

### Fire Warning Light (Red)

FIRE will **flash** when the smoke sensor detects sufficient quantities of smoke or heat. This is accompanied by the sounding of the horn.

FIRE will stay on **continuously** if the alarm was triggered remotely by another smoke sensor on your wireless network. A remotely triggered sensor will exit alarm mode after 5 minutes, unless during that time it was able to directly detect the fire.

**FIRE will continue to flash every 30 seconds (without the horn) for three days after exiting an alarm condition, or until the front button has been pressed and released.**

## Sensor Features and Functions

### Testing the Smoke Sensor

Every unit should be tested weekly to ensure proper operation.

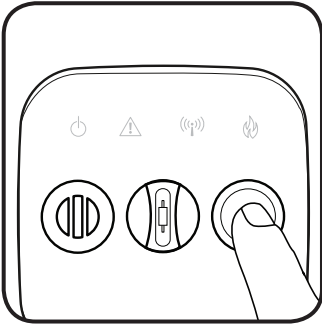

To test the smoke sensor, press and release the button on the front face.

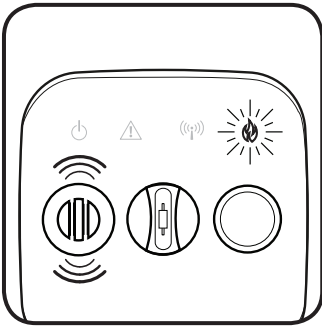

The sensor will sound with 3 beeps and FIRE will flash rapidly.

All four icons will strobe to indicate a successful test.

The unit will then send out a network test command and all other safety sensors on the network will perform the steps above.

*If the sensor fails, the horn will sound. Clean the unit (as described in this manual) and retest. If the sensor still fails, contact the manufacturer.*

### Silencing Nuisance Alarms

The smoke sensor is equipped with a silence feature that will decrease the sensitivity of the unit and silence nuisance alarms.

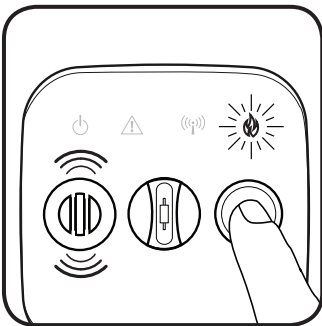

If in the course of normal activity, cooking smoke, steam or other gases cause the smoke sensor to activate, the unit can be silenced for ten minutes by pressing the button on the front face of the sensor.

The silence feature will also silence any alarms that were triggered remotely. However, the initiating smoke sensor must be silenced directly.

***If the quantity of smoke is too great, the alarm will not silence until the air has cleared sufficiently.***

# Deactivating the CFS10 Smoke Sensor

**ONCE DEACTIVATED, THE SMOKE SENSOR CANNOT BE REACTIVATED!  
If yellow light is flashing (see cleaning instructions on page 18).**

When the sensor's **End-of-Life** signal occurs, the unit must be deactivated and disposed of properly. Be sure and have a replacement smoke sensor available.

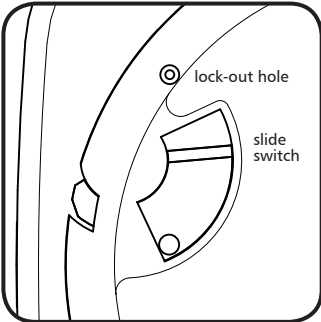

WARNING will **double flash** red every 30 seconds accompanied by the horn chirp, to indicate that the smoke sensor has reached its **End-of-Life**.

If the smoke sensor's End-of-Life signal has begun, remove the unit from its bracket.

Locate the slide switch and the deactivation lock-out hole on the back side of the smoke sensor.

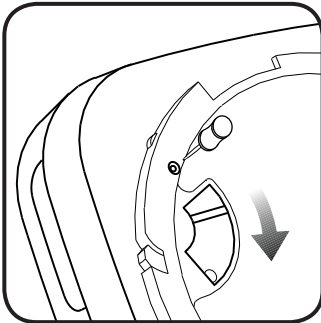

To deactivate the sensor, insert a pin or bent paperclip into the deactivation lock-out hole. Hold the pin down firmly.

With the pin still pressed firmly in place, slide the switch in the direction indicated by the arrow in the drawing.

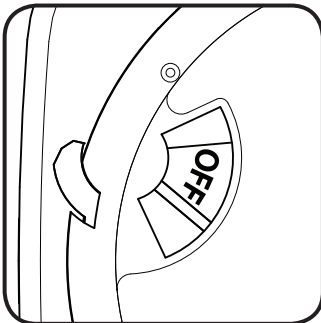

When the switch is fully positioned the word "OFF" will be exposed.

The switch will lock permanently into place. **The smoke sensor cannot be reactivated!**

**DO NOT MOVE THE SWITCH TO THE DEACTIVATE POSITION UNLESS YOUR INTENT IS TO DISPOSE OF THE UNIT!**

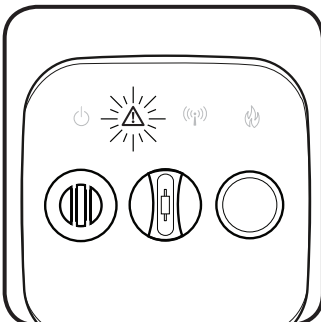

After the deactivation switch has been thrown, the WARNING icon will light up. This will deplete any remaining battery power over a period of several hours.

*After the light has gone out, responsibly dispose of the unit and **replace with a new smoke sensor!***

# Creating Your Wireless Network

The CFS10 Smoke Sensor communicates on its own private home network. This network is created simply by powering up new units one at a time.



Activate your first smoke sensor by moving the slide switch located on the back side of the unit in the direction indicated by the white arrow. The slide switch will lock into place when fully positioned.

**Note:** This switch is connected to a lock-out mechanism that will prevent installation on the bracket until activated.

**General Note:** It is easiest to first create the radio network while all sensors are located together, such as on a table.

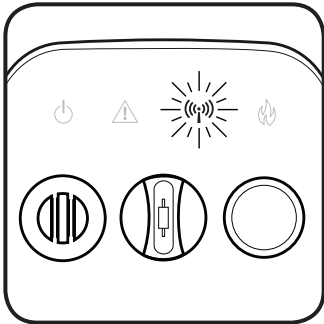

The blue WIRELESS light will begin to flash slowly.

While the blue WIRELESS light is flashing, additional units may be added to your network.

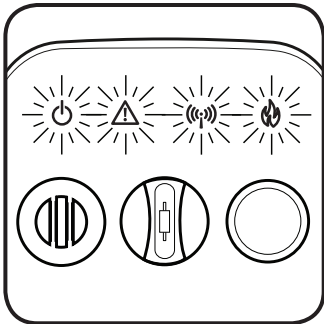

Activate your next smoke sensor by moving its slide switch as shown above.

The blue WIRELESS light will flash briefly, then the unit will chirp twice and all four of the lighted icons will strobe on in succession.

**This smoke sensor has been added to your network!**

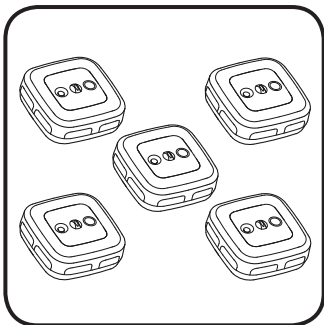

Continue activating each new smoke sensor, one unit at a time, until all sensors have been added to your network. This should include CO and heat sensors as well.

*One minute after activating the last unit, the WIRELESS light will stop flashing on the original sensor, and it will join the network. The network is now closed.*

**General Note:** The radio network is limited to 18 total units. Only 12 of these units may be smoke sensors, the remaining units can be CO and heat sensors or bedshakers.

# Adding a Sensor to Your Wireless Network

To add a sensor(s) to your existing home network, perform the following steps.

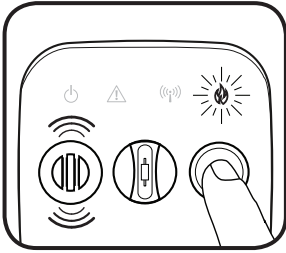

Select any sensor on the existing network. **Press and hold** the button on the front cover of the sensor. The red FIRE light (WARNING if CO sensor) will flash rapidly and the unit will sound three tones.

**Do not release the button.**

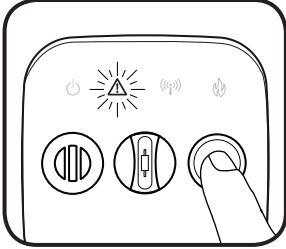

Next, the yellow WARNING light will flash slowly. Count to **5 flashes** of the yellow WARNING light and release the button.

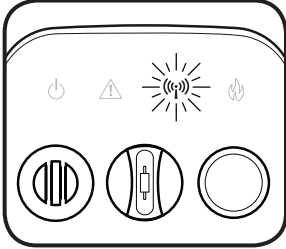

If done correctly, the blue WIRELESS light will now slowly pulse, indicating the network is again ready to receive additional sensors.

*If not, wait about 15 seconds and carefully repeat these steps.*

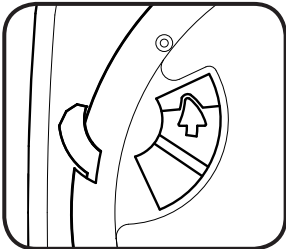

To add a **new** sensor, simply slide the switch located on the back side of the new unit in the direction indicated by the white arrow. It will lock into place when fully positioned.

*If the sensor being added was previously used, follow the steps on Page 14 to erase its network data. Then re-open this sensor's radio function using the first two steps in this section.*

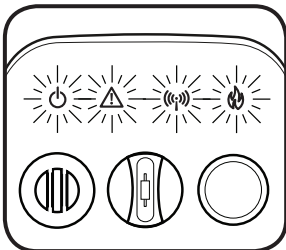

The blue WIRELESS light will flash briefly, then the unit will chirp twice and all four of the lighted icons will strobe on in succession.

**The sensor has been successfully added to your network!**

*Press the button on the original sensor and the WIRELESS light will stop flashing, or after one minute the WIRELESS light will stop flashing automatically and the network will close.*

## Removing a Sensor from a Wireless Network

In the event that a sensor must be removed from your network, the unit's network data must be erased from its memory.

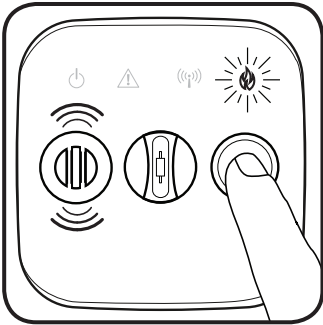

Press and hold the button on the front cover of the sensor. The red FIRE light will flash rapidly and the unit will sound three tones.

**Do not release the button.**

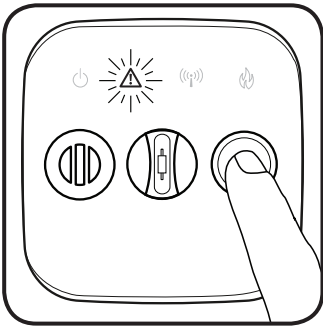

Next, the WARNING light will begin to flash yellow. Count **10 flashes** of the yellow WARNING light and release the button.

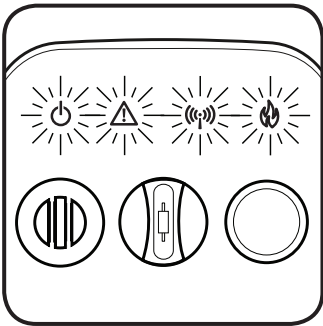

The sensor will chirp twice and all four of the lighted icons will strobe on.

**All network data has been erased from the sensor.** It will now perform as a single station alarm or it can be joined to a new network.

# Choosing the Mounting Location in a Room

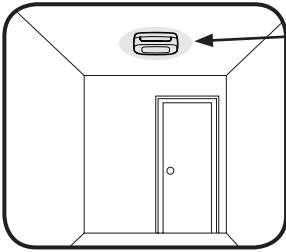

**BEST**  
Center on ceiling.

Note: Avoid placement of the smoke sensor close to ceiling fans or heating/air conditioning vents.

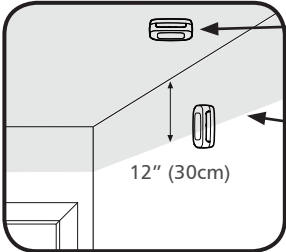

**ACCEPTABLE**  
On ceiling

**ACCEPTABLE**  
On wall, the top of the smoke sensor must be no more than 12" (30 cm) from the ceiling (if local codes permit wall mounting).

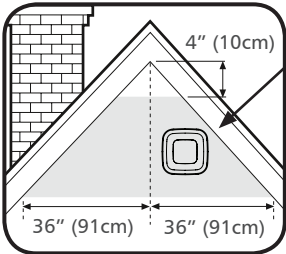

**ACCEPTABLE**  
On peaked ceilings or roofs, mount at least 4" (10cm) from the upper corner, but high enough to allow a maximum of 36" (91cm) of horizontal air space as measured off the peak.

Do not mount sensors between joists or rafters; mount on the exposed surface of the joist.

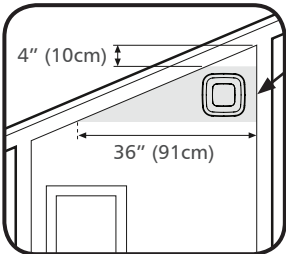

**ACCEPTABLE**  
On sloped ceilings, at least 4" (10cm) from the upper corner, but high enough to allow a maximum of 36" (91cm) of horizontal air space as measured off the peak.

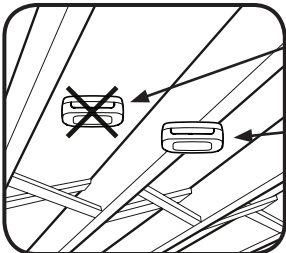

**NO!**  
Do not install between joists or rafters.

**OK**  
Install on exposed face of joist or rafter.

# How to Mount the Battery Powered Smoke Sensor

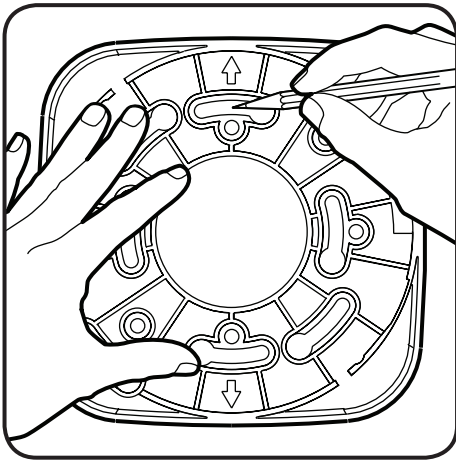

## 1 Mark

Place the mounting bracket against the ceiling or wall, and using the mounting bracket as a template, mark the top and bottom holes with a pencil.

If installing an AC powered sensor, with the electrical power off to the line, simply attach the bracket to the electrical box with the existing screws. See wiring diagram in this manual for connection information.

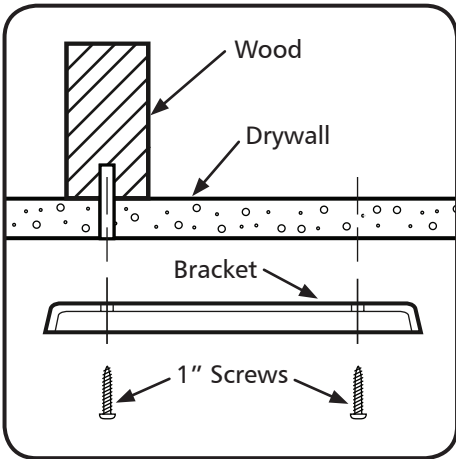

## 2 Mount the Bracket

If wood is present behind the drywall, a pilot hole can ease installation, but is not required. Create the optional pilot hole with a 1/8" (3mm) drill bit.

If the screw will only be secured into drywall, **DO NOT** drill a pilot hole.

Securely fasten the mounting bracket to the ceiling or wall using the two 1" screws provided. Do not over tighten.

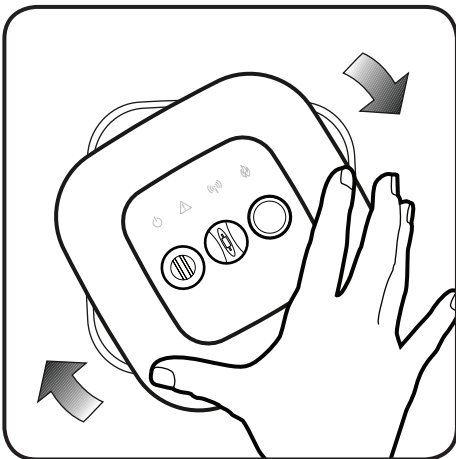

## 3 Lock Into Place

With the smoke sensor activated and the sensors fully networked together, position the smoke sensor onto the center of the bracket and turn clockwise. The unit will lock into place.

*Note: Smoke sensors are not to be used with detector guards unless the combination has been evaluated and found suitable for that purpose.*



# How to Wire and Mount the AC Powered Sensor

When installing an AC powered sensor (Model CFS10-AC), the mounting location is determined by the position of the electrical box that will power the alarm. **Electrical power to the box must be disconnected prior to smoke sensor connection and installation!**

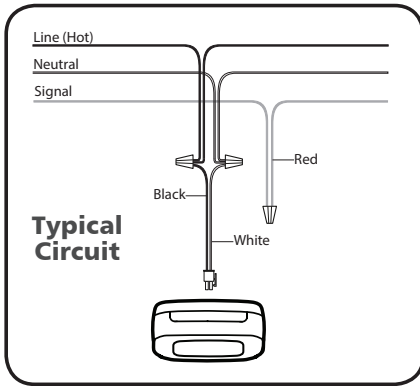

**With the AC power turned off**, connect the wire harness provided with the unit.

Connect the black wire of the harness to the black wire(s) in the electrical box.

Using the supplied orange wire nut, cap the red wire(s) (not used) and push it back inside the electrical box.

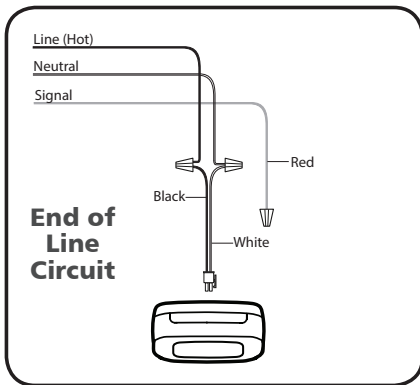

Connect the white wire of the harness to the white wire(s) in the electrical box.

Align and attach the mounting bracket with the two screws from the electrical box. Pass the wire harness through the center of the bracket.

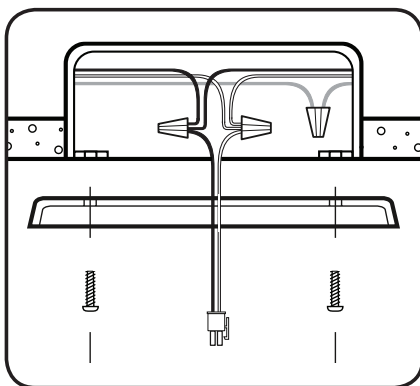

Plug the wire harness into the back of the smoke sensor.

Press and twist the sensor clockwise into place (see Step 4 of previous section).

Reconnect power to the AC lines of the smoke sensor circuit. The POWER icon will glow continuously.

## Cleaning Your Smoke Sensor

Over time dust and dirt might collect inside your smoke sensor, altering its performance. If this occurs, the unit can false alarm or the WARNING icon will flash and the horn will chirp every 30 seconds. To clean the unit perform the following:

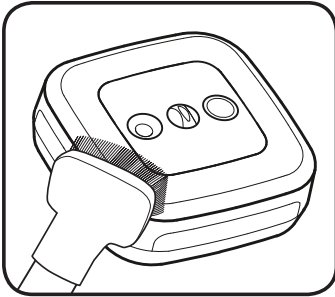

Remove the sensor from its bracket. If the smoke sensor is wired to the AC power lines, the wire harness must be disconnected.

Gently vacuum all the outside surfaces carefully or wipe with a clean cloth.

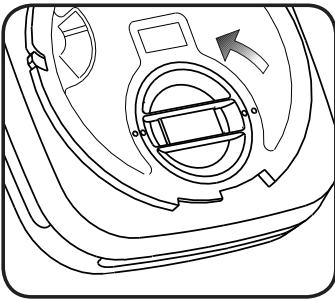

Locate the black smoke chamber on the back surface of the smoke sensor.

Twist the chamber counter-clockwise to remove.

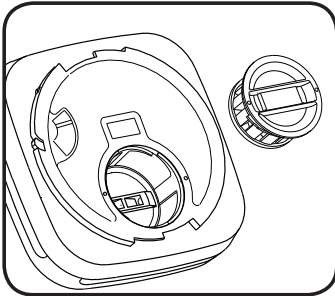

Carefully clean both the chamber **and** the empty alarm cavity with compressed air.

Re-install the smoke chamber into the cavity with a clockwise rotation. Align the dots on chamber and housing to ensure a proper fit.

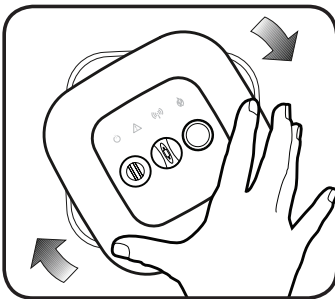

With the AC wire harness reconnected (if AC smoke sensor type), re-install on the ceiling/wall bracket with a clockwise twist.

Press and release the Test button on the front face to verify the unit is still functioning properly.

***If the WARNING icon flashing persists, contact the manufacturer to obtain instructions on returning the unit. DO NOT Deactivate the sensor.***

# Smoke Sensor Specifications

## Operating Voltage

CFS10	3VDC
CFS10-AC	120VAC, 60 Hz

## Standby Current

CFS10	less than 10uA
CFS10-AC	1mA (AC)/20uA (backup battery)

## Alarm Current

CFS10	120mA (max.)
CFS10-AC	25mA (max.)

## Battery Type

Non-replaceable Lithium Manganese

## Sensitivity

2.1 ± 1.1% Obscuration

## Operating Ambient Temperature

40°F - 100°F

## Operating Humidity

0 - 95% Non-condensing

## Alarm Dimensions

5.1" x 5.1" x 2.125"

## Mounting Base Dimensions

5.0" x 5.0"

## Weight

0.9 lbs (with bracket)

## Heat Sensing

Fixed Temperature	135°F
Rate of Rise	20°F / minute, > 100°F

## Listings

UL; cUL; CSFM

## FCC Compliance Statement and IC Notice:

This device complies with part 15 of the FCC Rules. This device complies with Industry Canada licence-exempt RSS standard(s). Operation is subject to the following two conditions: (1) This device may not cause harmful interference, and (2) this device must accept any interference received, including interference that may cause undesired operation.

This equipment has been tested and found to comply with the limits for a Class B digital device, pursuant to part 15 of the FCC Rules. These limits are designed to provide reasonable protection against harmful interference in a residential installation. This equipment generates, uses and can radiate radio frequency energy and, if not installed and used in accordance with the instructions, may cause harmful interference to radio communications. However, there is no guarantee that interference will not occur in a particular installation. If this equipment does cause harmful interference to radio or television reception, which can be determined by turning this equipment off and on, the user is encouraged to try to correct the interference by one or more of the following measures:

(1) Reorient or relocate the units. (2) Increase the separation between the equipment and receiver. (3) Connect the equipment into a different circuit from that to which the receiver is connected. (4) Consult the dealer or an experienced technician for help.

FCC Caution and IC Caution: Any Changes or modifications not expressly approved by the manufacturer could void the user's authority to operate the equipment.

# Important Fire/Emergency Safety Information

Be prepared for fire emergencies:

## Plan Your Escape

- Draw a floor plan of your home.
- Show two ways out of each room.
- Discuss escape routes with everyone in your home.
- Agree on an outside meeting place where you will gather after escaping.

## Be Prepared

- Familiarize every member of the household with the sound of the smoke, CO and heat alarms.
- Have everyone in the home memorize the fire department's emergency phone number.
- Instruct each person to call the emergency number from a neighbor's phone or a mobile phone used outside the home.
- Teach everyone to unlock and open all windows, and release security bars.
- Make sure security bars are equipped with quick-release devices.
- Keep exits clear and free from furniture and clutter.

## Practice!

- Hold home fire drills at least twice a year.

## Get Out and Stay Out

- Once you've escaped from a fire, do not go back inside for any reason.
- Make fire drills realistic by pretending some escape paths are blocked by smoke or fire.

## If you live in an apartment building

- Learn and practice your building's evacuation plan.
- If you hear a fire alarm, react immediately.
- Know the location of all building exits and fire alarm boxes.
- Use the stairs ... never use an elevator during a fire.
- If exits are locked or blocked, report the problem to your building's management.

## Escape Tips

- Close doors behind you as you escape to slow the spread of fire and smoke.
- If you have to escape through smoke, crawl on your hands and knees, keeping your head one to two feet above the floor, where the air will be clearest.
- Test the doorknob and spaces around the door with the back of your hand. If the door is warm, try another escape route. If the door is cool, open it slowly. Close it quickly if smoke pours through.

## **Warning! Limitations of Smoke Sensors**

Wireless smoke sensor have been proven to be both effective and reliable, but they may not be effective under all conditions. No sensor design can offer total protection of life and property. A smoke sensor is not a substitute for an adequate homeowner's fire insurance or life insurance policy.

Smoke sensor will not work without a source of power. The sensor will not operate and the alarm will not sound if the batteries have died or been deactivated. Or in the case of an AC powered sensor, the wiring has not been properly connected.

Radio communication between sensor units may fail to take place if significant changes to the home have occurred since installation and testing. Moving large objects such as a refrigerator or metal cabinet could impede sensor radio performance.

The sensor warning signal may not be heard. A deep sleeper, hearing-impaired person, young child or someone impaired by drugs or alcohol may not awaken in response to a sensor activation. This can occur even when a sensor is located inside the individual's bedroom. Be sure fire drills are practiced that take this possibility into account.

Current studies have shown smoke sensors may not awaken all sleeping individuals, and that it is the responsibility of individuals in the household that are capable of assisting others to provide assistance to those who may not be awakened by the alarm sound, or to those who may be incapable of safely evacuating the area unassisted.

Smoke sensors may not always activate and provide early enough warning. A smoke sensor will only activate when it is maintained in working order and sufficient smoke reaches the unit. Certain fires can originate inside of walls, attics or on the other side of closed doors. This may prevent smoke from reaching the smoke sensor.

Smoke sensors may not be effective in certain situations, such as: Fires where the victim is intimate with a flaming fire; for example, when a person's clothes catch fire while cooking; Fires where the smoke is prevented from reaching the sensor due to a closed door or other obstruction; Incendiary fires where the fire grows so rapidly that an occupant's egress is blocked even with the properly located sensors.

A Bed Shaker can not guarantee that a hearing impaired person will wake up during a fire.

**SMOKE SENSORS CAN NOT GUARANTEE THAT YOU WILL NEVER SUFFER ANY DAMAGE OR INJURY FROM A FIRE.**

## Limited Warranty

For a period of 24 months from the date of purchase, Applied Fire Technologies LLC warrants to you, the original purchaser, that your CFS10 Smoke Sensor will be free from defects in workmanship, materials, and construction under normal use and service. If a defect in workmanship, materials, or construction should cause your CFS10 Smoke Sensor to become inoperable within the warranty period, Applied Fire Technologies LLC will repair your CFS10 Smoke Sensor or furnish you with a new or rebuilt replacement CFS10 Smoke Sensor without charge to you except for your costs of shipping the CFS10 Smoke Sensor to Applied Fire Technologies LLC for warranty coverage. Your repaired or replacement CFS10 Smoke Sensor will be returned to you without charge and will be covered under this warranty for the balance of the warranty period.

This warranty will not apply if inspection of your CFS10 Smoke Sensor shows that the damage or failure was caused by abuse, misuse, abnormal usage, faulty installation, improper maintenance, or work other than that performed by authorized service personnel.

Any warranties implied under any State law, including implied warranties of merchantability and fitness for a particular purpose, are limited in duration to the period of this limited warranty. Some states do not allow limitations on how long an implied warranty lasts, so the above limitation may not apply to you. Neither the CFS10 manufacturer nor Applied Fire Technologies LLC will be liable for any loss, damage, incidental or consequential damages of any kind arising in connection with the sale, use, operation, inoperability, malfunction, or repair of your CFS10 Smoke Sensor. Some states do not allow the exclusion or limitation of incidental or consequential damages, so the above limitation or exclusion may not apply to you.

If a defect in workmanship, materials, or construction should cause your CFS10 Smoke Sensor to become inoperable within the warranty period, to obtain warranty coverage you must ship the CFS10 Smoke Sensor to Applied Fire Technologies LLC, with shipping costs prepaid by you. You must also pack the CFS10 Smoke Sensor to minimize the risk of it being damaged in transit. You must also enclose a return address. CFS10 Smoke Sensors returned for warranty service should be sent to: Applied Fire Technologies LLC, 825 W. Sandy Lake Rd., Suite 190, Coppel, TX 75019 USA, accompanied by proof of purchase.

If Applied Fire Technologies LLC receives a CFS10 Smoke Sensor in a damaged condition as the result of shipping, you will be notified and you may need to file a claim with the shipper.

This Limited Warranty gives you specific legal rights, and you may also have other rights which vary from state to state. This is your copy of the Limited Warranty on your CFS10 Smoke Sensor. Please retain it, along with proof of purchase showing the date of purchase and the identity of the purchaser, in a safe place.

## **Lifetime Product Replacement Guarantee**

After the above Limited Warranty has expired, commencing on the first day of the 25th month and extending through the lifetime of customer, the manufacturer of the CFS10 Smoke Sensor guarantees to repair or replace the smoke sensor at a preferred owner discounted price which includes shipping and handling and is adjusted annually. This Product Replacement Guarantee does not create any obligations or liabilities on the part of Applied Fire Technologies LLC.

This guarantee is extended only to the original purchaser and is available when the smoke sensor is sent to the manufacturer, with a description of any problem and proof-of-purchase. This replacement guarantee will not apply if the manufacturer's inspection reveals that the damage or failure is a result of abuse, misuse, improper maintenance, abnormal usage, or work performed by unauthorized service personnel. At least an annual cleaning (according to the directions supplied in this owner's manual or set forth at [www.homesafenetwork.com](http://www.homesafenetwork.com)) is recommended to prolong the useful life of your CFS10 Smoke Sensor.

To obtain a replacement under this guarantee, contact the manufacturer at [www.homesafenetwork.com](http://www.homesafenetwork.com) or at 1 (972) 304-3923, to receive information regarding current pricing and for the address to which you should send your CFS10 Smoke Sensor along with payment for your replacement alarm. Be sure to enclose your return address and daytime telephone number. The CFS10 manufacturer will ship the new replacement unit to you upon receipt of all of the foregoing materials and information.

This Product Replacement Policy does not alter or affect your Limited Warranty, set forth above.

## **Lifetime Fire Replacement Guarantee**

The CFS10 Smoke Sensor manufacturer guarantees to replace at no cost to the original owner any CFS10 Smoke Sensor that has been materially damaged or destroyed by an accidental fire. To obtain a replacement unit under this Lifetime Fire Replacement Guarantee, you must return the damaged or destroyed smoke sensor to the manufacturer within 90 days of the fire, accompanied by a complete activation report and verification report from the applicable fire department. To obtain a replacement under this guarantee, contact the manufacturer at [www.homesafenetwork.com](http://www.homesafenetwork.com) or at 1 (972) 304-3923, to receive information as to the address to which you should send your damaged or destroyed CFS10 Smoke Sensor and accompanying information.



825 W. Sandy Lake Road, Suite 190  
Coppell, TX 75019 USA  
[www.homesafenetwork.com](http://www.homesafenetwork.com)