



10 Year Carbon Monoxide Sensor Model CFCO10



Owner's Manual

- **Electro-Chemical Carbon Monoxide Gas Sensing**
- **Designed to Last Up to 10 Years**
- **Rate of Rise Temperature Sensing**
- **Fixed Temperature Sensing**
- **Proprietary Wireless Connectivity**
- **Compatible with the Comm Link and OmniShield App**

Assembled in the USA



SIGNALING
C UL US
LISTED

Table of Contents

General Information About Your Carbon Monoxide Sensor	page 3
Contents of Your Kit	page 4
General Warnings About Carbon Monoxide Gas	page 5
Understanding the Dangers of CO Gas Poisoning.....	page 6
Recommended Locations for Your CO Sensor	page 7
Areas Not Appropriate for CO Sensors	page 8
Complete Home Fire Protection	page 9
Acceptable Wireless Network Sensor Spacing	page 9
Sensor Features and Functions	page 10-11
Deactivating Your CFCO10 Sensor.....	page 12
Creating Your Wireless Network	page 13
Adding a Sensor to Your Radio Network	page 14
Removing a CO Sensor from Your Radio Network	page 15
Choosing the Mounting Location in a Room	page 16
How to Mount the CFCO10 Sensor	page 17
Sensor Specifications	page 18
Important Fire Safety Information	page 19
Warning! Limitations on CO Sensors	page 20
Limited Warranty	page 21
Replacement Guarantees	page 22

ATTENTION - This manual should be read, followed and retained for future reference.

Applied Fire Technologies recommends a combination of early-detecting Smoke Sensors, CO Sensors and reliable Heat Sensors installed in their appropriate locations throughout the home.

Smoke, CO and Heat Sensors are not a substitute for an adequate homeowner's fire/property insurance policy.

About Your New Carbon Monoxide Sensor

Thank you for purchasing the CFCO10 Carbon Monoxide Sensor. CO sensors play an important role in protecting your family and home from the dangers of carbon monoxide gas. Please carefully read and follow the information in this booklet to ensure that your sensor operates properly and is located in the areas best suited for activation.

What Makes the CFCO10 CO Sensor Different?

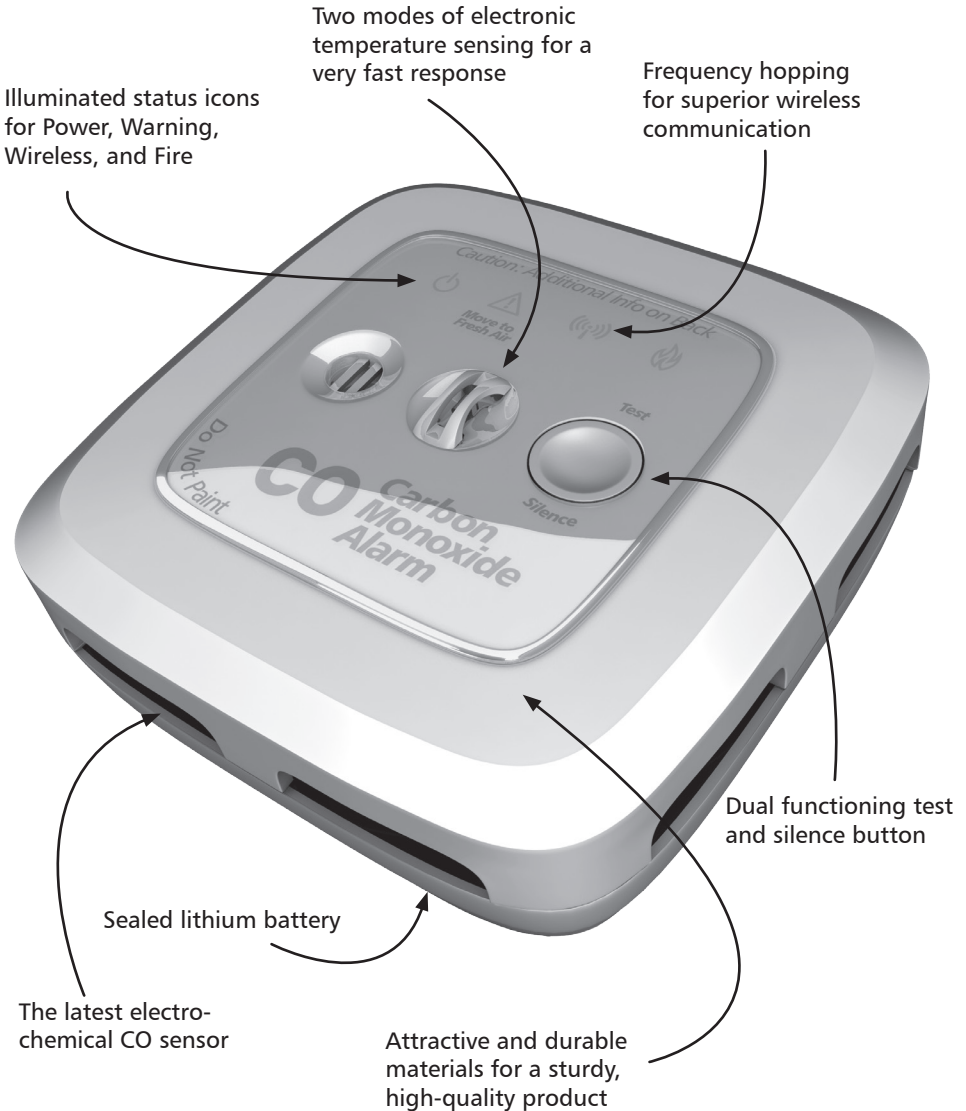

Contents of Your Kit

Please be sure the items below are included with your CO sensor:

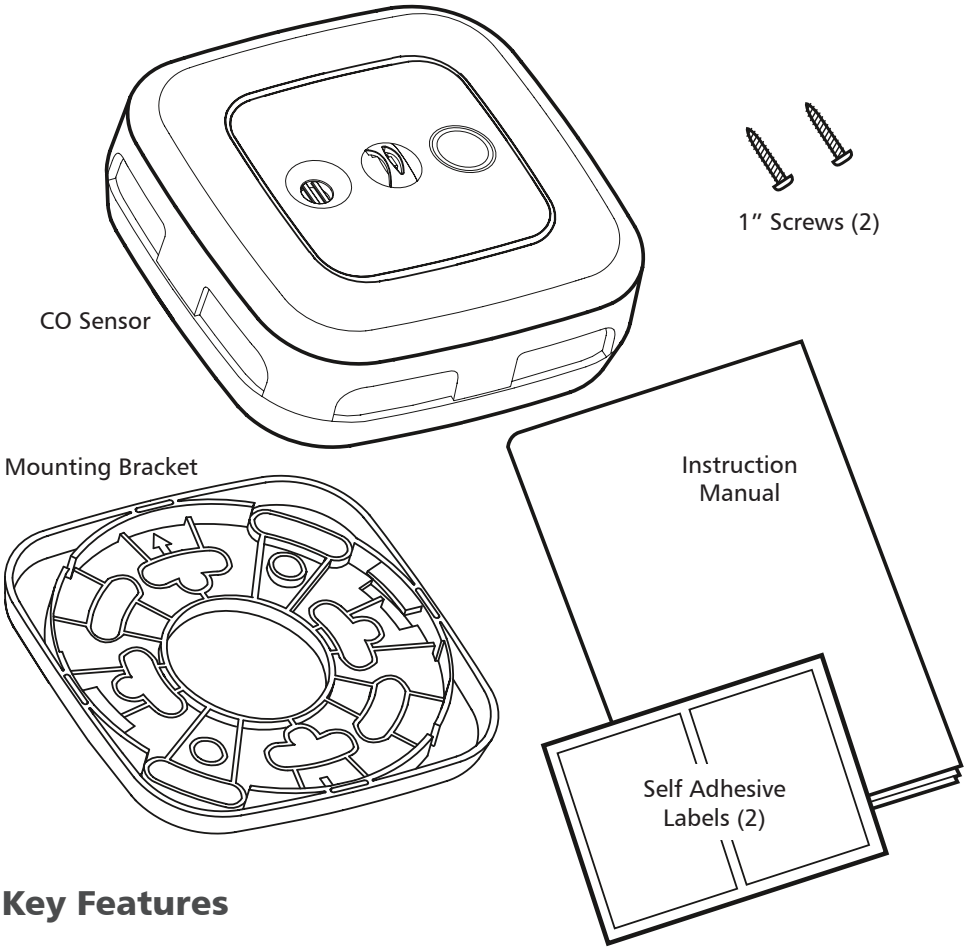

Key Features

- The latest electro-chemical CO sensing technology.
- Electronic temperature sensing with Rate of Rise and Fixed Temperature triggers.
- Fast response to CO gas exposure.
- Wireless communication to connect all products into their own unique home network.
- Powered by a sealed, long-life lithium manganese battery.
- Four illuminated icons to easily demonstrate the CO sensor's status.
- Multi-function button to allow for testing and silencing of unwanted triggering.
- Uniquely loud horn to notify occupants of CO gas and fire danger.
- Compatible with the Comm Link and OmniShield App.

General Warnings About Carbon Monoxide Gas

This carbon monoxide alarm is designed to detect carbon monoxide gas from ANY source of combustion. It is NOT designed to detect smoke, or any other gas types. The alarm also is equipped with Supplemental Temperature Sensing. This will activate the alarm if the temperature reaches either 135°F or the temperature rises by more than 20°F in a minute or less.

The CO alarm becomes susceptible to nuisance alarms when subject to prolonged exposure to certain cleaning supplies, hairsprays and perfume products. Care should be taken to install the CO alarm in spaces that are well ventilated where these types of items are stored or used.

WARNING

Activation of your CO alarm indicates the presence of carbon monoxide gas (CO) which can KILL YOU.

If your CO alarm signal sounds with the 4-beep pattern:

1. Press and release the Silence Button.
2. Call your emergency services () ____ - _____, fire department or 911.
3. Immediately move to fresh air - outdoors or by an open door or window.
 - Do a head count to check that all persons are accounted for.
 - Do not re-enter the premises nor move away from the open door/window until the emergency services responders have arrived, the premises have been aired out, and your alarm remains in its normal condition.
4. After following steps 1-3, if your alarm reactivates within a 24 hour period, repeat steps 1-3 and call a qualified appliance technician () ____ - _____ to investigate for sources of CO from fuel burning equipment and appliances, and inspect for proper operation of this equipment. If problems are identified during this inspection, have the equipment serviced immediately. Note any combustion equipment not inspected by the technician and consult the manufacturers' instructions, or contact the manufacturers directly for more information about CO safety and this equipment. Make sure that motor vehicles are not, and have not been, operating in an attached garage or adjacent to the residence.

Understanding the Dangers of CO Gas Poisoning

The following symptoms are related to Carbon Monoxide Poisoning and need to be discussed with ALL members of the household:

1. Mild Exposure: Slight headache, nausea, vomiting, fatigue (often described as "flu-like" symptoms).
2. Medium Exposure: Severe throbbing headache, drowsiness, confusion, fast heart rate.
3. Extreme Exposure: Unconsciousness, convulsions, cardiorespiratory failure, death.

Many cases of reported CARBON MONOXIDE POISONING indicate that while victims are aware they are not well, they become so disoriented they are unable to save themselves by either exiting the building or calling for assistance. Young children and household pets are typically the first affected.

Potential Problem Sources of CO Gas Inside the Home

The sources of Carbon Monoxide gas can be very difficult to locate due to the odorless, colorless nature of the gas, especially after the home has been aired-out prior to the investigators arrival. Look closely at the following:

1. Excessive spillage or reverse venting of fuel burning appliances:
 - Outdoor conditions such as wind direction and/or velocity, including high gusts of wind; heavy air in the vent pipes (cold/humid air with extended periods between cycles).
 - Negative pressure differential resulting from the use of exhaust fans.
 - Simultaneous operation of several fuel burning appliances competing for limited internal air.
 - Vent pipe connection vibrating loose from clothes dryers, furnaces, or water heaters.
 - Obstructions in, or unconventional vent pipe designs which amplify the above situations.
2. Extended operation of unvented fuel burning devices (range/oven, fireplace).
3. Temperature inversions which can trap exhaust gases near the ground.
4. Car idling in an open or closed attached garage, or near a home.
5. Poorly designed or maintained chimneys and/or vents.

Recommended Locations for your CO Sensor

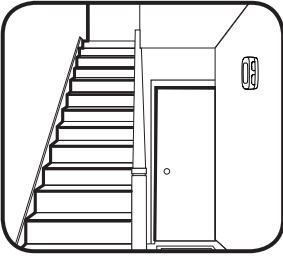

Hallways. A CO sensor is required to be centrally located outside of each sleeping area, and on every level of the home.

If your hallway is longer than 40 feet, install a CO sensor at both ends.

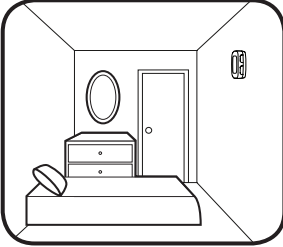

Bedrooms. A major threat from poisonous CO gas occurs at night when people are sleeping. For added protection, CO sensors can be installed in all sleeping rooms.

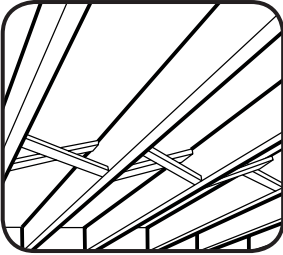

Basements. A CO sensor should be located on every level of the house, including the basement.

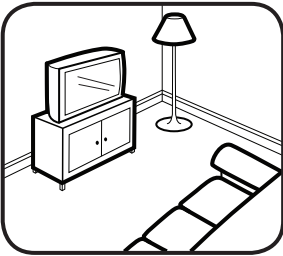

Living Spaces. To enhance safety, a CO sensor can be located in the living spaces of a home.

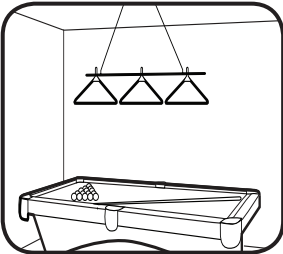

Recreation and Dining Rooms. For additional protection, a CO sensor can be located in the other living spaces of the home.

Note: Applicable building codes or other local laws may require the installation of CO and fire sensors in addition to the minimum recommended by this manual.

Areas Not Appropriate for CO Sensors

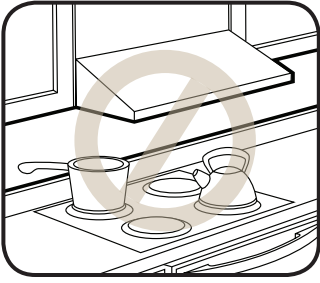

Kitchens. Do not install within 5 feet (1.5m) of kitchen appliances. The by-products of cooking food can affect the performance of the CO sensor.

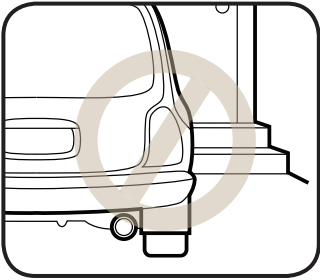

Garages. Do not install in garages. Exhaust gases from idling vehicles in an open or closed garage can trigger the CO sensor.

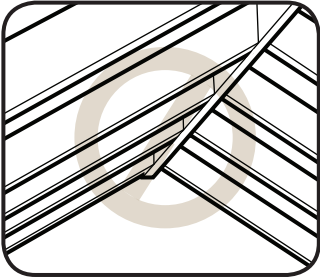



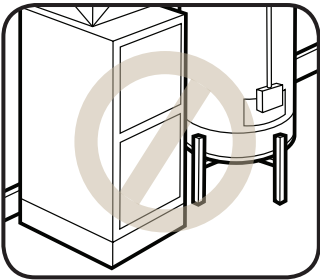



Attics. Do not install in attics. A CO sensor can be affected by dust, small insects or high and low temperatures. Do not install the unit in areas where the normal ambient temperature can go below 40°F (5°C) or exceed 100°F (38°C).



Utility and Furnace Rooms. Do not install close to equipment that can create steam and gas. Steam and exhaust gases can affect performance of CO sensors. CO sensors should be at least 20 feet (6m) from sources of combustion.

Complete Home Protection

Applied Fire Technologies recommends complete home fire/safety protection. This can be best achieved by installing a combination of Smoke, CO, Heat Sensors, BedShakers, Water Sensors and a Comm Link in the appropriate locations throughout the home.

-  Minimum Required Smoke Sensors
 -  Minimum Required CO Sensors
 -  Recommended Heat Sensors
 -  Recommended BedShakers
 -  Recommended Comm Link
 -  Recommended Water Sensors
- Required Interconnections

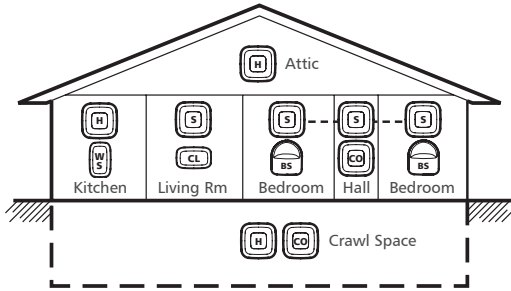

Single Story Homes

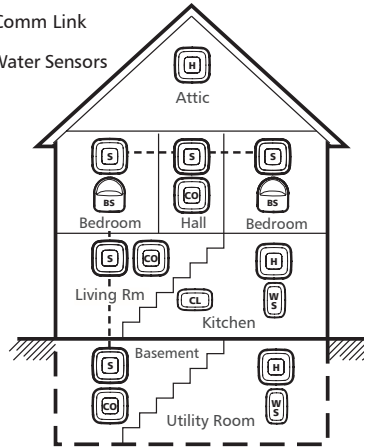

Two Story Homes

Acceptable Radio Network Sensor Spacing

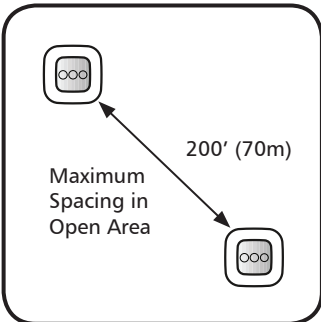

The proprietary network communicates using radio frequencies between 905.2MHz and 913.2MHz.

The range of the radio has been tested to 200 feet (70m) in open area distance testing.

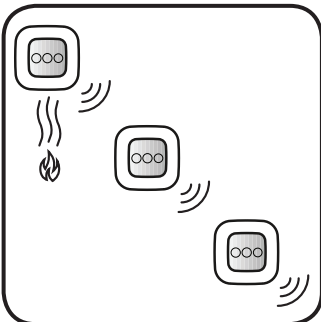

Each unit will also act as a repeating station, so any signal received by a sensor will be rebroadcast.

After final installation, test all sensors for proper radio inter-connection. Simply press and release the test button of a sensor while having a helper observe the remote sensors.

CO Sensor Features and Functions

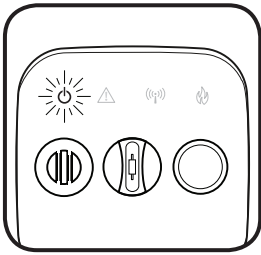

Power Indicator Light (Green)

On the CFCO10, the POWER icon will briefly flash once every 30 seconds when the unit has been activated.

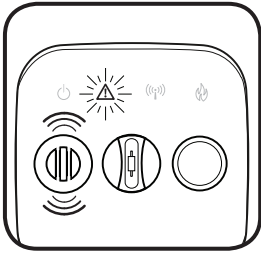

Warning Light (Red)

WARNING will flash rapidly when a CO sensor detects sufficient levels of CO gas. This will be accompanied by the 4-beep sounding of the horn.

WARNING will flash red every 30 seconds accompanied by the horn chirp, for a minimum of 7 days, to indicate **Low Battery**. Replace the unit.

WARNING will double flash red every 30 seconds accompanied by the horn chirp, to indicate that the CO sensor has reached its **End-of-Life**. Replace the unit.

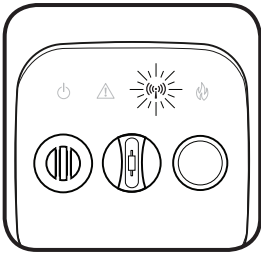

Wireless Networking Light (Blue)

WIRELESS will flash once per second to indicate the radio network is open to accept additional sensors into the network.

WIRELESS will cease to flash one minute after the last sensor has been added to the network or immediately after the front button has been pressed.

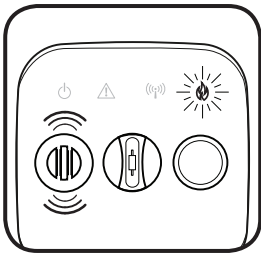

Fire Warning Light (Red)

The FIRE warning light can be triggered in two ways on the CO sensor, either exposure to sufficient heat or remotely by another sensor on the wireless network.

FIRE will **flash** when the alarm detects sufficient quantities of heat. This is accompanied by the sounding of the horn.

FIRE will stay on **continuously** if the unit was triggered remotely by another sensor on your radio network. A remotely triggered sensor will exit alarm mode after 5 minutes, unless during that time it was able to directly detect the fire.

FIRE will continue to flash twice per minute (without the horn) for three days after exiting an alarm condition, or until the front button has been pressed and released.

CO Sensor Features and Functions

End-of-Life Feature

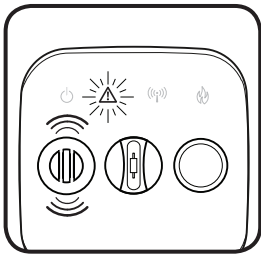

The CFCO10 has been designed to last for a period of up to ten years. When the unit has reached the end of its useful life, the End of Life Signal will occur.

Note: Certain conditions, such as a high ambient temperature or a very dry environment, can reduce the life of the CO sensor to less than ten years.

When the End-of-Life Signal occurs, follow the deactivation procedure on Page 12, and **replace the unit.**

Testing the CO Sensor

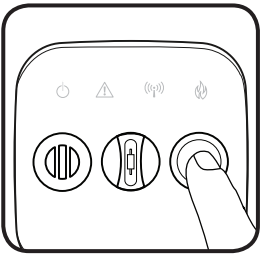

Every CO sensor should be tested at least weekly to ensure proper operation.

To test the CO sensor, press and release the button on the front face.

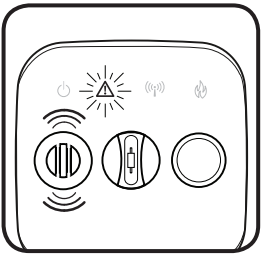

The unit will sound with 4 beeps (2X) and the WARNING light will flash red rapidly.

All four icons will strobe to indicate proper function.

The sensor will then send out a network test command and all other sensors on the wireless network will perform the same internal test.

If the unit fails the self-test, the horn will sound a single long tone. If this occurs, replace the unit.

Silencing Nuisance Alarms

The CFCO10 sensor is equipped with a silence feature that can silence the unit.

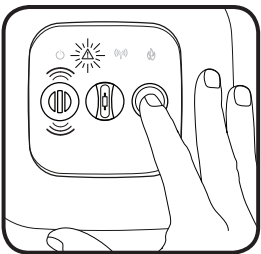

If during normal operation the alarm is triggered, **and all appropriate safety precautions are being taken**, the sensor can be silenced for six minutes by pressing the button on the front face of the unit.

The silence feature will also silence any sensors that were triggered remotely. However, the initiating unit must be silenced directly.

If the quantity of CO gas is too great, the unit will silence only briefly, then resume.

Deactivating the CFCO10 Sensor

When the unit's End-of-Life signal occurs, the CO sensor must be deactivated and disposed of properly. Be sure and have a replacement unit available.

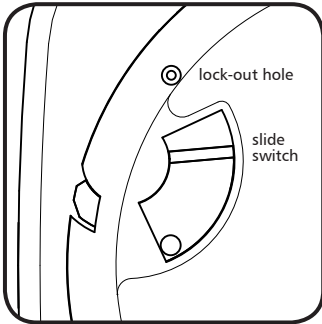

If the CO sensor's End-of-Life signal has begun, remove the unit from its bracket.

Locate the slide switch and the deactivation lock-out hole.

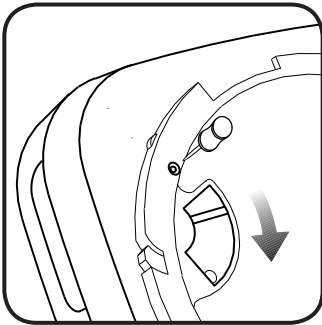

To deactivate the sensor, insert a pin or bent paperclip into the deactivation lock-out hole. Hold the pin down firmly.

With the pin still pressed firmly in place, slide the switch in the direction indicated by the arrow in the drawing.



When the switch is fully positioned the word "OFF" will be exposed.

The switch will lock permanently into place.
The CO sensor cannot be reactivated!

DO NOT MOVE THE SWITCH TO THE DEACTIVATE POSITION UNLESS YOUR INTENT IS TO DISPOSE OF THE UNIT!

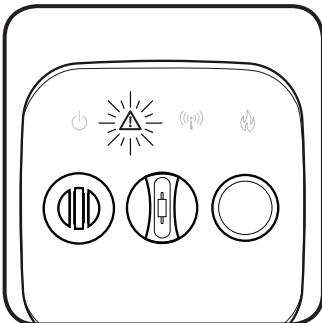

After the deactivation switch has been thrown, the WARNING light will turn on. This will deplete any remaining battery power over a period of several hours.

*After the light has gone out, responsibly dispose of the unit and **replace with a new CO sensor!***

Creating Your Wireless Network

The CFCO10 Sensor communicates on its own private home network. This network is created simply by powering up new sensors one at a time.

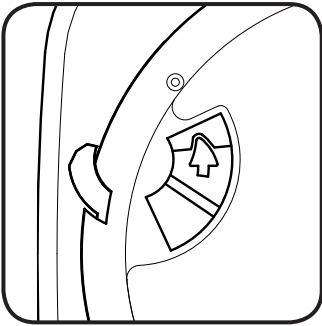

Activate your first CO sensor by moving the slide switch located on the back side of the unit in the direction indicated by the arrow.

The slide switch will lock into place when fully positioned.

Note: This switch is connected to a lock-out mechanism that will prevent installation on the bracket until activated.

General Note: It is easiest to first create the wireless network while all sensors are located together, such as on a table.

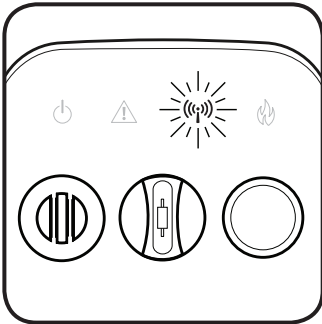

The blue WIRELESS light will begin to flash slowly.

While the blue WIRELESS light is flashing, additional sensors may be added to your network.

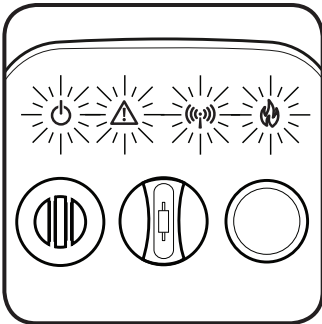

Activate your next unit by moving its slide switch as shown above.

The blue WIRELESS light will flash briefly, then the sensor will chirp twice and all four of the lighted icons will strobe on in succession.

This CO sensor has been added to your network!

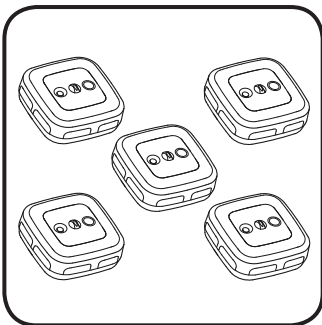

Continue activating each new sensor, one unit at a time, until all sensors have been added to the network. This should include smoke and heat sensors as well.

One minute after activating the last sensor, the WIRELESS light will stop flashing on the original sensor, and it will join the network. The network is now closed.

General Note: The wireless network is limited to 18 total units. Only 12 of these units may be smoke sensors, the remaining units can be CO sensors, heat sensors or bedshakers.

Adding a Sensor to Your Wireless Network

To add a sensor(s) to your existing home network, perform the following steps.

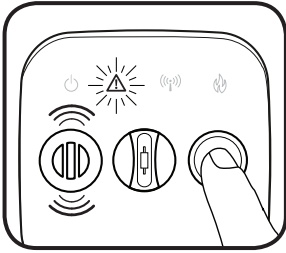

Select any sensor on the existing network. **Press and hold** the button on the front cover of the alarm. The **red** WARNING light (FIRE if alarm is a smoke sensor) will flash rapidly and the unit will sound three or four tones.

Continue holding the button down.

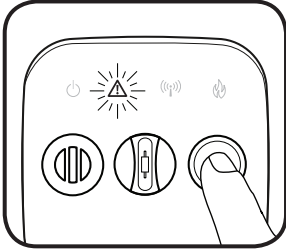

Next, the **yellow** WARNING light will flash slowly. Count to **5 flashes** of the yellow WARNING light and release the button.

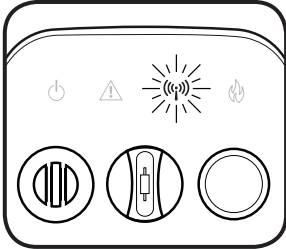

If done correctly, the blue WIRELESS light will now slowly pulse, indicating the network is again ready to receive additional devices.

If not, wait about 15 seconds and carefully repeat these steps.

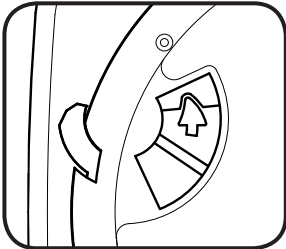

To add a **new** sensor, simply slide the switch located on the back side of the new sensor in the direction indicated by the white arrow. It will lock into place when fully positioned.

If the sensor being added was previously used, follow the steps on Page 15 to erase its network data. Then re-open this unit's wireless function using steps 1-2 in this section.

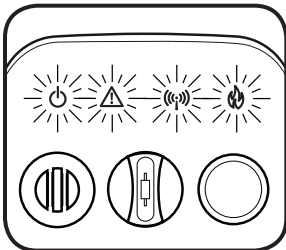

The blue WIRELESS light will flash briefly, then the unit will chirp twice and all four of the lighted icons will strobe on in succession.

The sensor has been successfully added to your network!

Press the button on the original sensor and the WIRELESS light will stop flashing, or after one minute the WIRELESS light will stop flashing automatically and the network will close.

Removing a CO Sensor from a Wireless Network

In the event that a sensor must be removed from your network, the sensor's network data must be erased from its memory.

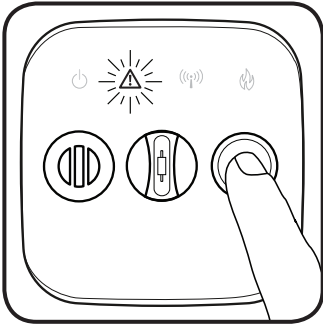

Press and hold the button on the front cover of the sensor. The red WARNING light will flash rapidly and the unit will sound four tones.

Continue holding the button down.

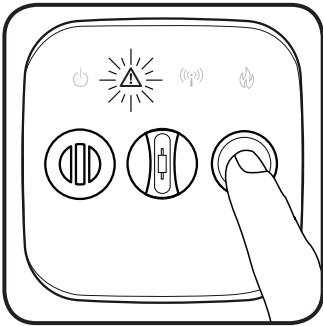

Next, the WARNING light will begin to flash yellow. Count **10 flashes** of the yellow WARNING light and release the button.

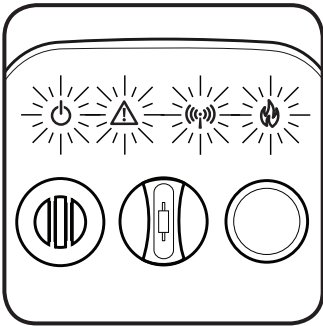

The sensor will chirp twice and all four of the lighted icons will strobe on.

All network data has been erased from the sensor. It will now perform as a single station device or it can be joined to a new network.

Choosing the Mounting Location in a Room

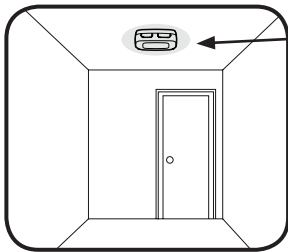

BEST
Center on ceiling.

Note: Avoid placement of sensors close to ceiling fans or heating/air conditioning vents.

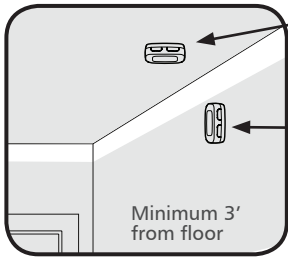

ACCEPTABLE
On ceiling

ACCEPTABLE
On wall, at least 4" (10cm) from ceiling, and at least 3 feet (0.9m) from the floor.

Applying the Self-Adhesive Warning Labels

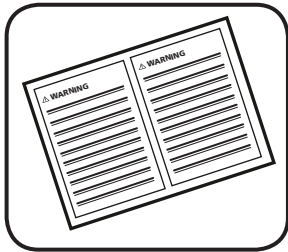

This CO sensor was shipped with two (2) self-adhesive Warning Labels.

Add the telephone numbers of your emergency service provider and that of a qualified technician in spaces provided.

Place one label next to the CO sensor, and the other label near a source of fresh air where your family plans to gather if the sensor indicates the presence of carbon monoxide gas.

Cleaning Your Sensor

Over time, dust might collect within your sensor, potentially reducing its performance. To clean the sensor, perform the following:

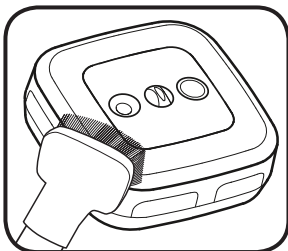

Remove the unit from its bracket.

Vacuum all the external surfaces carefully. Wipe with a clean, dry cloth. Do not use cleaners or solvents.

Press and release the Test button on the front face to verify the unit is still functioning properly and reinstall on the wall/ceiling.

Do not submerge the CO sensor in water. The sensitive electronics will be damaged!

How to Mount the CO Sensor

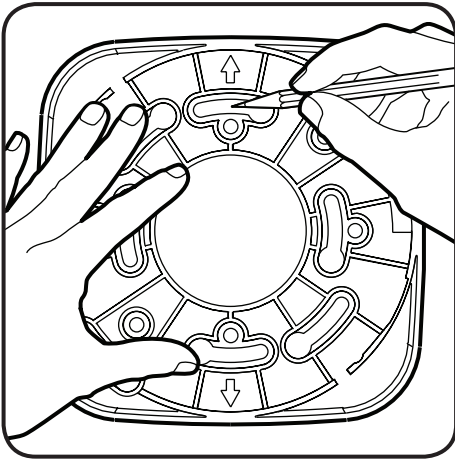

1 Mark

Place the mounting bracket against the ceiling or wall, and using the mounting bracket as a template, mark the top and bottom holes with a pencil.

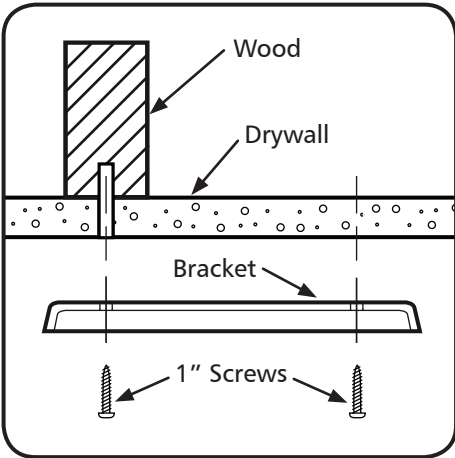

2 Mount the Bracket

If wood is present behind the drywall, a pilot hole can ease installation, but is not required. Create the optional pilot hole with a 1/8" (3mm) drill bit.

If the screw will only be secured into drywall, **DO NOT** drill a pilot hole.

Securely fasten the mounting bracket to the ceiling or wall using the two 1" screws provided. Do not over tighten.

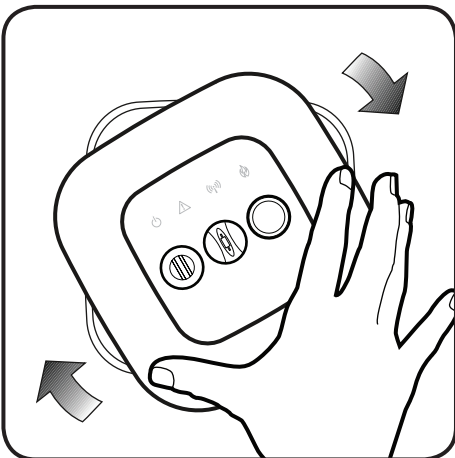

3 Lock Into Place

With the CO sensor activated and the sensors fully networked together, position the unit onto the center of the bracket and turn clockwise. The device will lock into place.

CO Sensor Specifications

Operating Voltage	3VDC
Battery Type	Non-replaceable Lithium-Manganese
Sensitivity	70 PPM: 60 to 80 minutes 150 PPM: 10 to 15 minutes 400 PPM: 4 to 8 minutes 30 PPM or less: unit will not activate
Sensor Life	Up to 10 Years
Operating Ambient Temperature	40°F - 100°F
Operating Humidity	10 - 95% Non-condensing
Unit Dimensions	5.1" x 5.1" x 1.75"
Weight	0.86 lbs
Heat Sensing	
Fixed Temperature	135°F
Rate of Rise	20°F / minute, > 100°F
Listings	c UL us; CSFM

FCC Compliance Statement and IC Notice:

This device complies with part 15 of the FCC Rules. This device complies with Industry Canada licence-exempt RSS standard(s). Operation is subject to the following two conditions: (1) This device may not cause harmful interference, and (2) this device must accept any interference received, including interference that may cause undesired operation.

This equipment has been tested and found to comply with the limits for a Class B digital device, pursuant to part 15 of the FCC Rules. These limits are designed to provide reasonable protection against harmful interference in a residential installation. This equipment generates, uses and can radiate radio frequency energy and, if not installed and used in accordance with the instructions, may cause harmful interference to radio communications. However, there is no guarantee that interference will not occur in a particular installation. If this equipment does cause harmful interference to radio or television reception, which can be determined by turning this equipment off and on, the user is encouraged to try to correct the interference by one or more of the following measures:

(1) Reorient or relocate the units. (2) Increase the separation between the equipment and receiver. (3) Connect the equipment into a different circuit from that to which the receiver is connected. (4) Consult the dealer or an experienced technician for help.

FCC Caution and IC Caution: Any changes or modifications not expressly approved by the manufacturer could void the user's authority to operate the equipment.

Les changements ou modifications non approuvés expressément par la partie responsable de la conformité pourrait annuler l'autorité de l'utilisateur à faire fonctionner l'équipement.

Le présent appareil est conforme aux CNR d'Industrie Canada applicables aux appareils radio exempts de licence. L'exploitation est autorisée aux deux conditions suivantes : (1) l'appareil ne doit pas produire de brouillage, et (2) l'utilisateur de l'appareil doit accepter tout brouillage radioélectrique subi, même si le brouillage est susceptible d'en compromettre le fonctionnement.

Important Fire and Emergency Safety Information

Be prepared for fire emergencies:

Plan Your Escape

- Draw a floor plan of your home.
- Show two ways out of each room.
- Discuss escape routes with everyone in your home.
- Agree on an outside meeting place where you will gather after escaping.

Be Prepared

- Familiarize every member of the household with the sound of the smoke, CO and heat sensors.
- Have everyone in the home memorize the fire department's emergency phone number.
- Instruct each person to call the emergency number from a neighbor's phone or a mobile phone used outside the home.
- Teach everyone to unlock and open all windows, and release security bars.
- Make sure security bars are equipped with quick-release devices.
- Keep exits clear and free from furniture and clutter.

Practice!

- Hold home fire and emergency drills at least twice a year.

Get Out and Stay Out

- Once you have escaped from a fire, do not go back inside for any reason.
- Make fire drills realistic by pretending some escape paths are blocked by smoke or fire.

If you live in an apartment building

- Learn and practice your building's evacuation plan.
- If you hear a fire or CO alarm, react immediately.
- Know the location of all building exits and fire alarm boxes.
- Use the stairs ... never use an elevator during a fire.
- If exits are locked or blocked, report the problem to your building's management.

Escape Tips

- Close doors behind you as you escape to slow the spread of fire and smoke.
- If you have to escape through smoke, crawl on your hands and knees, keeping your head one to two feet above the floor, where the air will be clearest.
- Test the doorknob and spaces around the door with the back of your hand. If the door is warm, try another escape route. If the door is cool, open it slowly. Close it quickly if smoke pours through.

WARNING! Limitations of CO Sensors

Wireless CO sensors have been proven to be both effective and reliable, but they may not be effective under all conditions. No alarm/sensor design can offer total protection of life and property. A CO sensor is not a substitute for an adequate homeowner's property insurance or life insurance policy.

WARNING - This product is intended for use in ordinary indoor locations of family living units. It is not designed to measure compliance with Occupational Safety and Health Administration (OSHA) commercial or industrial standards.

CO sensors will not work without a source of power. The sensor will not operate and the sensor will not sound if the battery has died or the sensor has been deactivated.

CAUTION - This CO sensor will only indicate the presence of carbon monoxide gas near the sensor. Carbon monoxide gas may be present in other areas of the home.

Radio communication between sensor units may fail to take place if significant changes to the home have occurred since installation and testing. Moving large objects such as a refrigerator or metal cabinet could impede sensor radio performance.

Sensor warning signals may not be heard. A deep sleeper, hearing-impaired person, young child or someone impaired by drugs or alcohol may not awaken in response to a sensor activation. This can occur even when a sensor is located inside the individual's bedroom. Be sure emergency exit drills are practiced that take this possibility into account.

CO sensors may not always activate and provide early enough warning. A CO sensor will only activate when it is maintained in working order and sufficient amounts of CO gas reaches the unit.

Individuals with medical problems may consider using warning devices which provide audible and visual signals for carbon monoxide concentrations under 30ppm.

This device is designed to protect individuals from the acute effects of carbon monoxide exposure. It will not fully safeguard individuals with specific medical conditions. If in doubt, consult a medical practitioner.

WARNING - The installation of CO sensors should not be used as a substitute for proper installation, use, and maintenance of fuel-burning appliances, including appropriate ventilation and exhaust systems.

CO SENSORS CANNOT GUARANTEE THAT YOU WILL NEVER SUFFER ANY ILLNESS OR INJURY FROM EXPOSURE TO CARBON MONOXIDE GAS.

Limited Warranty

For a period of 24 months from the date of purchase, Applied Fire Technologies LLC warrants to you, the original purchaser, that your CFCO10 CO Sensor will be free from defects in workmanship, materials, and construction under normal use and service. If a defect in workmanship, materials, or construction should cause your CFCO10 CO Sensor to become inoperable within the warranty period, Applied Fire Technologies LLC will repair your CFCO10 CO Sensor or furnish you with a new or rebuilt replacement CFCO10 CO Sensor without charge to you except for your costs of shipping the CFCO10 CO Sensor to Applied Fire Technologies LLC for warranty coverage. Your repaired or replacement CFCO10 CO Sensor will be returned to you without charge and will be covered under this warranty for the balance of the warranty period.

This warranty will not apply if inspection of your CFCO10 CO Sensor shows that the damage or failure was caused by abuse, misuse, abnormal usage, faulty installation, improper maintenance, or work other than that performed by authorized service personnel.

Any warranties implied under any State law, including implied warranties of merchantability and fitness for a particular purpose, are limited in duration to the period of this limited warranty. Some states do not allow limitations on how long an implied warranty lasts, so the above limitation may not apply to you. Neither the CFCO10 manufacturer nor Applied Fire Technologies LLC will be liable for any loss, damage, incidental or consequential damages of any kind arising in connection with the sale, use, operation, inoperability, malfunction, or repair of your CFCO10 CO Sensor. Some states do not allow the exclusion or limitation of incidental or consequential damages, so the above limitation or exclusion may not apply to you.

If a defect in workmanship, materials, or construction should cause your CFCO10 CO Sensor to become inoperable within the warranty period, to obtain warranty coverage you must ship the CFCO10 CO Sensor to Applied Fire Technologies LLC, with shipping costs prepaid by you. You must also pack the CFCO10 CO Sensor to minimize the risk of it being damaged in transit. You must also enclose a return address. CFCO10 CO Sensors returned for warranty service should be sent to: Applied Fire Technologies LLC, 825 W. Sandy Lake Rd., Ste. 190, Coppell, TX 75019 USA, accompanied by proof of purchase.

If Applied Fire Technologies LLC receives a CFCO10 CO Sensor in a damaged condition as the result of shipping, you will be notified and you may need to file a claim with the shipper.

This Limited Warranty gives you specific legal rights, and you may also have other rights which vary from state to state. This is your copy of the Limited Warranty on your CFCO10 CO Sensor. Please retain it, along with proof of purchase showing the date of purchase and the identity of the purchaser, in a safe place.

Lifetime Product Replacement Guarantee

After the Limited Warranty has expired, commencing on the first day of the 25th month and extending through the lifetime of customer, the manufacturer of the CFCO10 Carbon Monoxide Sensor guarantees to repair or replace the CO Sensor at a preferred owner discounted price which includes shipping and handling and is adjusted annually. This Product Replacement Guarantee does not create any obligations or liabilities on the part of Applied Fire Technologies LLC.

This guarantee is extended only to the original purchaser and is available when the CO sensor is sent to the manufacturer, with a description of any problem and proof-of-purchase. This replacement guarantee will not apply if the manufacturer's inspection reveals that the damage or failure is a result of abuse, misuse, improper maintenance, abnormal usage, or work performed by unauthorized service personnel. At least an annual cleaning (according to the directions supplied in this owner's manual or set forth at www.homesafenetwork.com) is recommended to prolong the useful life of your CFCO10 CO Sensor.

To obtain a replacement under this guarantee, contact the manufacturer at www.homesafenetwork.com or at 1 (972) 304-3923, to receive information regarding current pricing and for the address to which you should send your CFCO10 CO Sensor along with payment for your replacement sensor. Be sure to enclose your return address and daytime telephone number. The CFCO10 manufacturer will ship the new replacement unit to you upon receipt of all of the foregoing materials and information.

This Product Replacement Policy does not alter or affect your Limited Warranty.

Lifetime Fire Replacement Guarantee

The CFCO10 sensor manufacturer guarantees to replace at no cost to the original owner any CFCO10 sensor that has been materially damaged or destroyed by an accidental fire. To obtain a replacement sensor under this Lifetime Fire Replacement Guarantee, you must return the damaged or destroyed CO sensor to the manufacturer within 90 days of the fire, accompanied by a complete activation report and verification report from the applicable fire department. To obtain a replacement under this guarantee, contact the manufacturer at Applied Fire Technologies LLC, 825 W. Sandy Lake Rd., Ste. 190, Coppel, TX 75019 USA or at 1 (972) 304-3923 to receive information as to the address to which you should send your damaged or destroyed CFCO10 sensor and accompanying information.



825 W. Sandy Lake Road, Suite 190
Coppell, TX 75019 USA
www.homesafenetwork.com

*Model CFCO10
10-Year Battery Life
Return to Above Address
for All Service Needs*